

美盛防爆插头插座

MAISON Ex-proof plug & socket

Ex



凯思理科技（广州）有限公司

Custlink Technology (GuangZhou) Ltd.

MSFC 系列 | 16A 塑料防爆插头插座 |

MSFC series 16A Ex-proof plastic socket & plug

▶ 应用场合 Application

1 区、2 区爆炸性气体和 21 区、22 区可燃性粉尘易爆区域

Application: Suitable for zone 1 and zone 2 under potentially explosive atmospheres, zone 21 and zone 22 under dust potentially explosive situations

防爆标志: Ex de IIC T6 Gb Ex tD A21 IP66 T80 °C

Ex mark : Ex de IIC T6 Gb Ex tD A21 IP66 T80 °C

适用环境温度: -20°C - +40 °C

Permissible ambient temperature : -20°C - +40 °C

额定电压: 3P 可至 400V / 4P 可至 690 V/ 5P 可至 500V

Rated voltage : Up to 400V,3-pole / up to 690V,4-pole/ up to 500V , 5-pole

额定电流: 16A

Rated current:16A

防护等级: IP66

Degree of protection:IP66



壁式插座 Wall socket

进线开孔: M25x1.5

Cable entrance :M25x1.5

电缆接入: ϕ 8-17mm

Cable gland : ϕ 8-17mm

接线端子: 2x1-4 mm²

Connecting terminals : 2x1-4mm²

壳体材质: 玻璃纤维增强聚酯

Enclosure material : glass-fibre reinforced polyester

插头 Plug

电缆接入: ϕ 8-19mm

Cable gland : ϕ 8-19mm

接线端子: 1x1.0-2.5mm²

Connecting terminals : 1x1.0-2.5 mm²

壳体材质: 聚酰胺

Enclosure material : polyester

法兰插座 Flange socket

接线端子: 2x1-4mm²

Connecting terminals : 2x1-4mm²



壳体材质: 聚酰胺

Enclosure material : polyester

MSFC 系列 | 16A-3P 塑料防爆插头插座 |

MSFC series 16A-3P Ex-proof plastic socket & plug

▶ Ex-plug & socket suitable for zone1 ,zone2 & zone 21 ,zone 22

类别 Type	时钟位置 h	电压 Voltage	颜色 Colour	重量 Weight	订货号 Order No.
壁式插座 Wall Socket 	 4h	110-130 V		1.2 kg	MSFC016134
	 6h	200-250 V		1.2 kg	MSFC016136
法兰插座 Flange Socket 	 4h	110-130 V		0.4kg	MSFC016234
	 6h	200-250 V		0.4kg	MSFC016236
插头 Plug 	 4h	110-130 V		0.35kg	MSFC016334
	 6h	200-250 V		0.35kg	MSFC016336

▶ 外形尺寸 Outline dimension

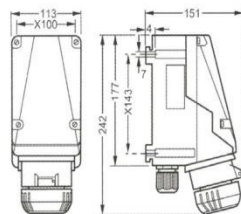

16A 3P 壁式插座 Wall socket 3-pole

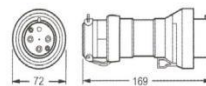

16A 3P 插头 Plug 3-pole

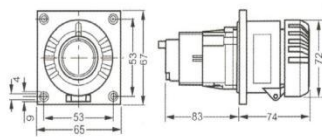

16A 3P 法兰插座 Flange socket 3-pole

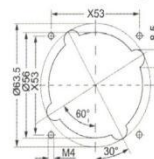



























法兰安装尺寸 Assembly dimensions flange socket

MSFC 系列 | 16A-4P 塑料防爆插头插座 |

MSFC series 16A-4P Ex-proof plastic socket & plug

▶ Ex-plug & socket suitable for zone1 ,zone2 & zone 21 ,zone 22

类别 Type	时钟位置 h	电压 Voltage	颜色 Colour	重量 Weight	订货号 Order No.
壁式插座 Wall Socket 		200-250 V		1.8 kg	MSFC016149
		380-415 V		1.8 kg	MSFC016146
		480-500 V		1.9 kg	MSFC016147
		600-690 V		1.9 kg	MSFC016145
法兰插座 Flange Socket 		200-250 V		1.0 kg	MSFC016249
		380-415 V		1.0 kg	MSFC016246
		480-500 V		1.0 kg	MSFC016247
		600-690 V		1.0 kg	MSFC016245
插头 Plug 		200-250 V		0.7kg	MSFC016349
		380-415 V		0.7kg	MSFC016346
		480-500 V		0.7kg	MSFC016347
		600-690 V		0.7kg	MSFC016345

▶ 外形尺寸 Outline dimension

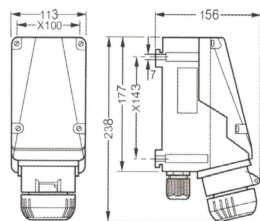

16A 4P 壁式插座 Wall socket 4-pole

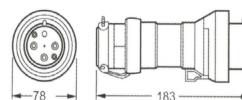

16A 4P 插头 Plug 4-pole

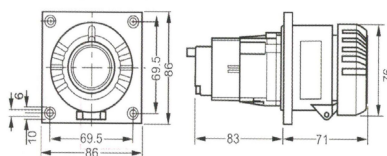

16A 4P 法兰插座 Flange socket 4-pole

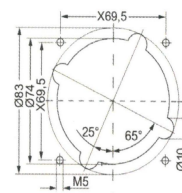

法兰安装尺寸 Assembly dimensions flange socket

MSFC 系列 | 16A-5P 塑料防爆插头插座 |

MSFC series 16A-5P Ex-proof plastic socket & plug

▶ Ex-plug & socket suitable for zone1 ,zone2 & zone 21 ,zone 22

类别 Type	时钟位置 h	电压 Voltage	颜色 Colour	重量 Weight	订货号 Order No.
壁式插座 Wall Socket 	 6h	200-250 V 380-415 V		1.9kg	MSFC016156
法兰插座 Flange Socket 	 6h	200-250 V 380-415 V		1.0kg	MSFC016256
插头 Plug 	 6h	200-250 V 380-415 V		0.7kg	MSFC016356

▶ 外形尺寸 Outline dimension

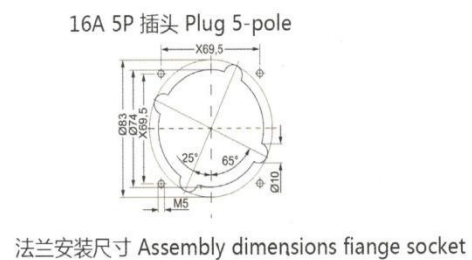
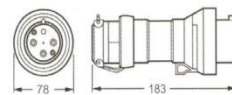
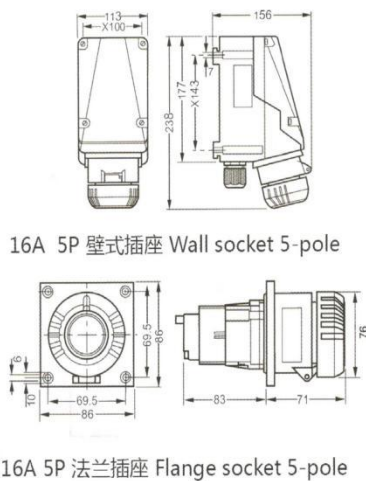

MSFC 系列 | 32A 塑料防爆插头插座 |

MSFC series 32A Ex-proof plastic socket & plug

▶ 应用场合 Application

1 区、2 区爆炸性气体和 21 区、22 区可燃性粉尘易爆区域

Application: Suitable for zone 1 and zone 2 under potentially explosive atmospheres, zone 21 and zone 22 under dust potentially explosive situations

防爆标志 : Ex de IIC T6 Gb Ex tD A21 IP66 T80 °C

Ex mark : Ex de IIC T6 Gb Ex tD A21 IP66 T80 °C

适用环境温度 : -20°C - +40 °C

Permissible ambient temperature : -20°C - +40 °C

额定电压 : 可至 690 V

Rated voltage : Up to 690V

额定电流 : 32A

Rated current: 32A

防护等级 : IP66

Degree of protection: IP66



壁式插座 Wall socket

进线开孔 : M40x1.5

Cable entrance : M40x1.5

电缆接入 : ϕ 17-28mm

Cable gland : ϕ 17-28mm

接线端子 : 2x4-10 mm²

Connecting terminals : 2x4-10mm²

壳体材质 : 玻璃纤维增强聚酯

Enclosure material : glass-fibre reinforced polyester

插头 Plug

电缆接入 : ϕ 17-28mm

Cable gland : ϕ 17-28mm

接线端子 : 1.0-6mm²

Connecting terminals : 1.0-6 mm²

壳体材质 : 聚酰胺

Enclosure material : polyester

法兰插座 Flange socket

接线端子 : 2x4-10mm²

Connecting terminals : 2x4-10mm²



























壳体材质 : 聚酰胺

Enclosure material : polyester

MSFC 系列 | 32A-4P 塑料防爆插头插座 |

MSFC series 32A-4P Ex-proof plastic socket & plug

▶ Ex-plug & socket suitable for zone1 ,zone2 & zone 21 ,zone 22

类别 Type	时钟位置 h	电压 Voltage	颜色 Colour	重量 Weight	订货号 Order No.
壁式插座 Wall Socket 	 9h	200-250 V		1.8 kg	MSFC032149
	 6h	380-415 V		1.8 kg	MSFC032146
	 7h	480-500 V		1.9 kg	MSFC032147
	 5h	600-690 V		1.9 kg	MSFC032145
法兰插座 Flange Socket 	 9h	200-250 V		1.0 kg	MSFC032249
	 6h	380-415 V		1.0 kg	MSFC032246
	 7h	480-500 V		1.0 kg	MSFC032247
	 5h	600-690 V		1.0 kg	MSFC032245
插头 Plug 	 9h	200-250 V		0.7kg	MSFC032349
	 6h	380-415 V		0.7kg	MSFC032346
	 7h	480-500 V		0.7kg	MSFC032347
	 5h	600-690 V		0.7kg	MSFC032345

▶ 外形尺寸 Outline dimension

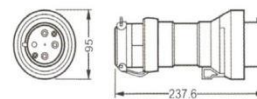
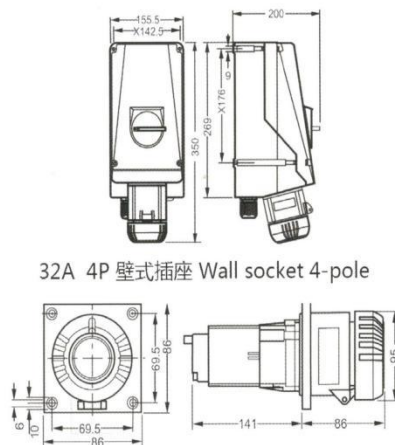

32A 4P 插头 Plug 4-pole

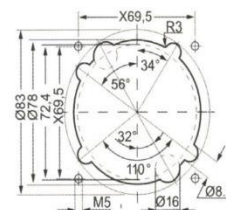



法兰安装尺寸 Assembly dimensions flange socket

MSFC 系列 | 32A-5P 塑料防爆插头插座 |

MSFC series 32A-5P Ex-proof plastic socket & plug

▶ Ex-plug & socket suitable for zone1 ,zone2 & zone 21 ,zone 22

类别 Type	时钟位置 h	电压 Voltage	颜色 Colour	重量 Weight	订货号 Order No.
壁式插座 Wall Socket 	 6h	200-250 V 380-415 V		1.9kg	MSFC032156
法兰插座 Flange Socket 	 6h	200-250 V 380-415 V		1.0kg	MSFC032256
插头 Plug 	 6h	200-250 V 380-415 V		0.7kg	MSFC032356

▶ 外形尺寸 Outline dimension

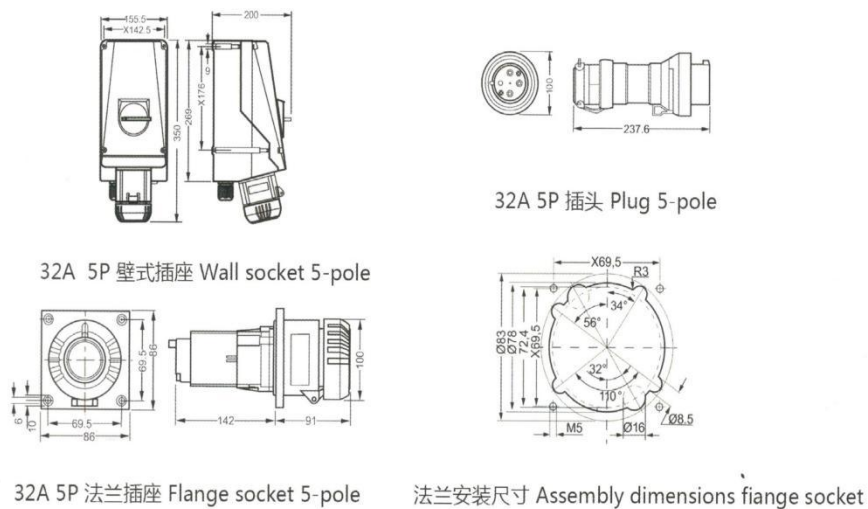

MSFC 系列 | 63A 塑料防爆插头插座 |

MSFC series 63A Ex-proof plastic socket & plug

▶ 应用场合 Application

1 区、2 区爆炸性气体和 21 区、22 区可燃性粉尘易爆区域

Application: Suitable for zone 1 and zone 2 under potentially explosive atmospheres, zone 21 and zone 22 under dust potentially explosive situations

防爆标志 : Ex de IIC T5 Gb Ex tD A21 IP66 T80 °C

Ex mark : Ex de IIC T5 Gb Ex tD A21 IP66 T80 °C

适用环境温度 : -20°C - +40 °C

Permissible ambient temperature : -20°C - +40 °C

额定电压 : 可至 690 V

Rated voltage : Up to 690V

额定电流 : 63A

Rated current: 63A

防护等级 : IP66

Degree of protection: IP66

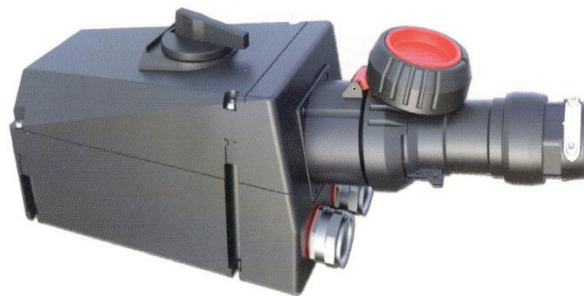

壁式插座 Wall socket

进线开孔 : M50x1.5

Cable entrance : M50x1.5

电缆接入 : ϕ 22-35mm

Cable gland : ϕ 22-35mm

接线端子 : 2x4-25 mm²

Connecting terminals : 2x4-25mm²

壳体材质 : 玻璃纤维增强聚酯

Enclosure material : glass-fibre reinforced polyester

插头 Plug

电缆接入 : ϕ 19-34mm

Cable gland : ϕ 19-34mm

接线端子 : 4-16mm²

Connecting terminals : 4-16 mm²



















壳体材质 : 聚酰胺

Enclosure material : polyester

MSFC 系列 | 63A-4P 塑料防爆插头插座 |

MSFC series 63A-4P Ex-proof plastic socket & plug

▶ Ex-plug & socket suitable for zone1 ,zone2 & zone 21 ,zone 22

类别 Type	时钟位置 h	电压 Voltage	颜色 Colour	重量 Weight	订货号 Order No.
壁式插座 Wall Socket 	 9h	200-250 V		8.1kg	MSFC063149
	 6h	380-415 V		8.1kg	MSFC063146
	 7h	480-500 V		8.2 kg	MSFC063147
	 5h	600-690 V		8.2kg	MSFC063145
插头 Plug 	 9h	200-250 V		0.75kg	MSFC063349
	 6h	380-415 V		0.75kg	MSFC063346
	 7h	480-500 V		0.75kg	MSFC063347
	 5h	600-690 V		0.75kg	MSFC063345

▶ 外形尺寸 Outline dimension

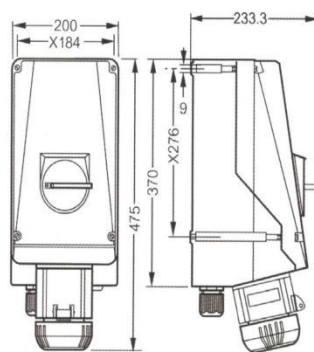

63A 4P 壁式插座 Wall socket 4-pole

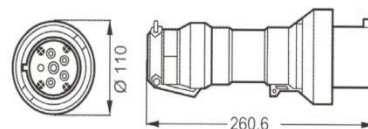

63A 4P 插头 Plug 4-pole

MSFC 系列 | 63A-5P 塑料防爆插头插座 |

MSFC series 63A-5P Ex-proof plastic socket & plug

▶ Ex-plug & socket suitable for zone1 ,zone2 & zone 21 ,zone 22

类别 Type	时钟位置 h	电压 Voltage	颜色 Colour	重量 Weight	订货号 Order No.
壁式插座 Wall Socket		 6h	200-250 V 380-415 V	 8.1kg	MSFC063156
插头 Plug		 6h	200-250 V 380-415 V	 0.75kg	MSFC063356

▶ 外形尺寸 Outline dimension

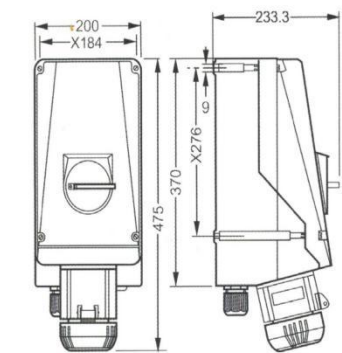

63A 5P 壁式插座 Wall socket 5-pole

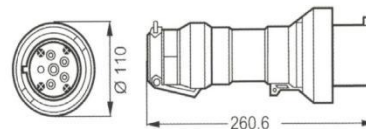

63A 5P 插头 Plug 5-pole

MSFC 系列 | 125A 塑料防爆插头插座 |

MSFC series 125A Ex-proof plastic socket & plug

▶ 应用场合 Application

1 区、2 区爆炸性气体和 21 区、22 区可燃性粉尘易爆区域

Application: Suitable for zone 1 and zone 2 under potentially explosive atmospheres, zone 21 and zone 22 under dust potentially explosive situations

防爆标志 : Ex de IIC T4 Gb Ex tD A21 IP66 T80 °C

Ex mark : Ex de IIC T4 Gb Ex tD A21 IP66 T80 °C

适用环境温度 : -20°C - +40 °C

Permissible ambient temperature : -20°C - +40 °C

额定电压 : 可至 690 V

Rated voltage : Up to 690V

额定电流 : 125A

Rated current: 125A

防护等级 : IP66

Degree of protection: IP66



壁式插座 Wall socket

进线开孔 : M50x1.5

Cable entrance : M50x1.5

电缆接入 : ϕ 20-38mm

Cable gland : ϕ 27-48mm

接线端子 : 2x4-70 mm²

Connecting terminals : 2x4-70mm²

壳体材质 : 玻璃纤维增强聚酯

Enclosure material : glass-fibre reinforced polyester

插头 Plug

电缆接入 : ϕ 31-55mm

Cable gland : ϕ 31-55mm

接线端子 : 1x4-35mm²

Connecting terminals : 1x4-35 mm²

壳体材质 : 聚酰胺

Enclosure material : polyester

MSFC 系列 | 125A-4P 塑料防爆插头插座 |

MSFC series 125A-4P Ex-proof plastic socket & plug

▶ Ex-plug & socket suitable for zone1 ,zone2 & zone 21 ,zone 22

类别 Type	时钟位置 h	电压 Voltage	颜色 Colour	重量 Weight	订货号 Order No.
壁式插座 Wall Socket 	 9h	200-250 V		12.3kg	MSFC125149
	 6h	380-415 V		12.3kg	MSFC125146
	 7h	480-500 V		12.3kg	MSFC125147
	 5h	600-690 V		12.3kg	MSFC125145
插头 Plug 	 9h	200-250 V		0.9kg	MSFC125349
	 6h	380-415 V		0.9kg	MSFC125346
	 7h	480-500 V		0.9kg	MSFC125347
	 5h	600-690 V		0.9kg	MSFC125345

▶ 外形尺寸 Outline dimension

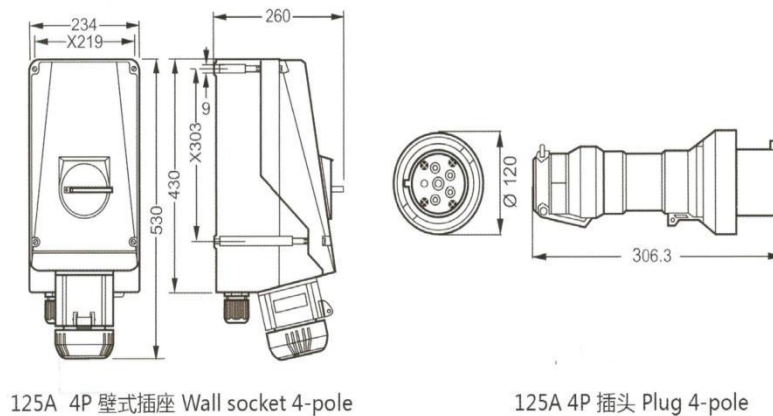



125A 4P 壁式插座 Wall socket 4-pole

125A 4P 插头 Plug 4-pole

MSFC 系列 | 125A-5P 塑料防爆插头插座 |

MSFC series 125A-5P Ex-proof plastic socket & plug

▶ Ex-plug & socket suitable for zone1 ,zone2 & zone 21 ,zone 22

类别 Type	时钟位置 h	电压 Voltage	颜色 Colour	重量 Weight	订货号 Order No.
壁式插座 Wall Socket		200-250 V 380-415 V		13kg	MSFC125156
插头 Plug		200-250 V 380-415 V		1.2kg	MSFC125356

▶ 外形尺寸 Outline dimension

